

Read all instructions before assembling crib. Follow all product warnings on crib. Keep the manual in the sleeve provided for future use.



WARNING: Failure to follow these warnings and assembly instructions could result in serious injury or death.

Caution: Any mattress used in this crib must be at least 27 1/4 in by 51 5/8 in (69 cm x 131 cm) with a thickness not exceeding 6 in (15 cm).

•This crib is to be assembled by an adult•

- Warning: Strings can cause strangulation! Do not place items with a string around a child's neck, such as hood strings or pacifier cords. Do not suspend strings over a crib or attach strings to toys.
- DO NOT place a crib near a window where cords from blinds or drapes may strangle a child.
- Keep wall decorations, especially those with strings, completely out of a child's reach.
- Before each usage or assembly, inspect crib for damaged hardware, loose joints, missing parts or sharp edges. DO NOT use the crib if any parts are missing or broken. Ask your dealer or contact manufacturer for replacement parts and instructional literature if needed. DO NOT substitute parts.
- Check fasteners periodically for tightness. Do not overtighten. This may cause distortion or breakage.
- When a child is able to climb out, reaches the height of 35 in. (89cm) or when the height of the side rail is less than 3/4 of the child's height, the crib shall no longer be used.
- DO NOT use a water mattress with this crib. •If refinishing, use a non-toxic finish specified for children's products.
- When a child is able to pull to a standing position, set the mattress to the lowest position and remove bumper pads, large toys and other objects that could serve as steps for climbing out.
- Never use plastic shipping bags or other plastic films as mattress covers because they can cause suffocation.
- Do not tie pacifiers, necklaces, or any other items around a child's neck or on crib parts. This could cause strangulation.
- Use a crib as a crib, not as a play pen. Remember that a crib is not a substitute for a parent's supervision.
- Parents should ensure a safe environment for their child by checking the crib regularly before placing the child in the product. Please make sure that every component is properly and securely in place.
- Infants can suffocate in gaps between crib sides and a mattress too small.



WARNING: **Infants can suffocate on soft bedding.**
•NEVER add a pillow, comforter or padding.
•NEVER place additional padding under an infant.

- To help prevent strangulation, tighten all fasteners. A child can trap parts of body or clothing on loose fasteners.
- To reduce the risk of SIDS, pediatricians recommend healthy infants be placed on their back to sleep, unless otherwise advised by your physician.



WARNING: WHEN USING AS TODDLER BED

Failure to follow these warnings and assembly instructions could result in serious injury or death.

- The intended user's minimum age must be at least 15 months old and maximum weight must not exceed 50lbs
 - DO NOT place bed near windows where cords from blinds or drapes may strangle a child
 - DO NOT place items with a string, cord, or ribbon, around a child's neck, such as a hood, strings, or pacifier cords
 - DO NOT suspend strings over a toddler bed for any reason
 - The mattress intended for this bed shall be a full-size crib mattress that must be at least 27-1/4 inches by 51-5/8 inches with a thickness not exceeding 6 inches.
-

CARE AND MAINTENANCE:

Periodically check your crib for any loose bolts and screws and tighten where needed. If crib is damaged, do not use - contact us for replacement parts. Clean with mild soap that is safe on wood using a soft rag. Rinse and dry thoroughly. Avoid excess moisture.

ONE YEAR LIMITED WARRANTY:

Defective parts will be replaced within a one year period from date of original purchase. Missing parts will be replaced within 30 days from the date of original purchase. Baby Appleseed warrants only new units purchased in it's original packaging. The warranty does not cover used, secondhand or demos and is non-transferable.

Any damaged or defective part that result from normal wear and tear, abuse, negligence, improper use or alteration to the finish, design, and hardware of the crib, or the assembly of this product are not covered. The specific legal rights of this warranty may vary from state to state. Some states do not allow any exclusion or limitation of incidental or consequential damages. Some states do not allow limitation on how long an implied warranty lasts.

Please visit our website at **www.babyappleseed.com**.

There you can find more product information, register for your product, contact us or request replacement parts.

Or you can write to us at:
Baby Appleseed
15269 Don Julian Road
City of Industry, CA 91745



Chelmsford

Assembly Manual

We would like to thank you for purchasing one of our cribs. Because of customers like you, we are able to make a positive impact on our environment, shaping and building a better future for all of our children.

Although caring for the environment is a priority for us at Baby Appleseed, you should know that our first and foremost concern is building a safe and sound product for you and your baby. Featuring solid wood construction and no moving parts, our cribs are designed to withstand the test of time; this provides for a safe and sturdy product that will grow with your baby.

Again, thank you for your support and welcome to our family.

Sincerely,
Baby Appleseed

Hardware

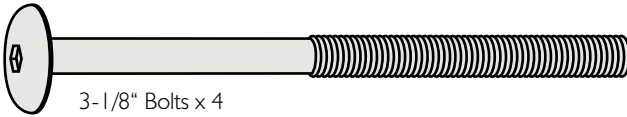

3-1/8" Bolts x 4



Small Wood Screws x 7

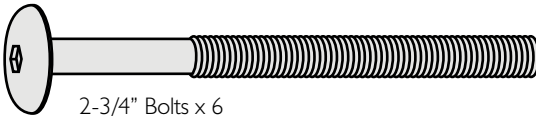

2-3/4" Bolts x 6



Large Wood Screws x 3

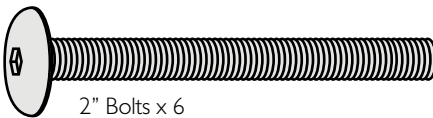

2" Bolts x 6

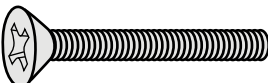

1-1/4" Phillips Bolts x 8



Butterfly Nuts x 8

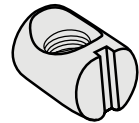

Barrel Nuts x 4



Hex Wrench x 1



Locking Washers x 8

Be sure to assemble the furniture in a dirt free environment to avoid scratching or damaging the wood.

Box Contents

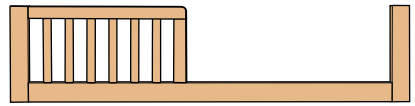
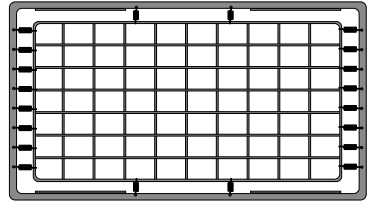
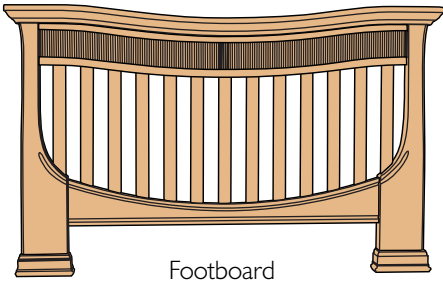
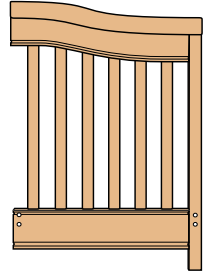
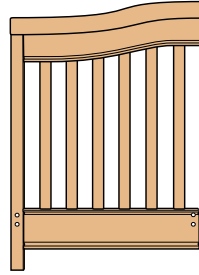
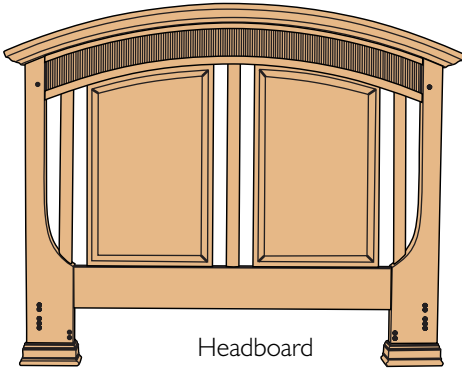

Drawer Parts



Left Drawer Panel x 1



Right Drawer Panel x 1

USE OF A POWER TOOL TO ASSEMBLE THIS CRIB MAY STRIP THE WOOD. PLEASE DO NOT USE.

1.) Installing mattress support onto cross bars

Hardware needed:



1A Swing the arm up as shown. Please note that the style of mattress support may vary.

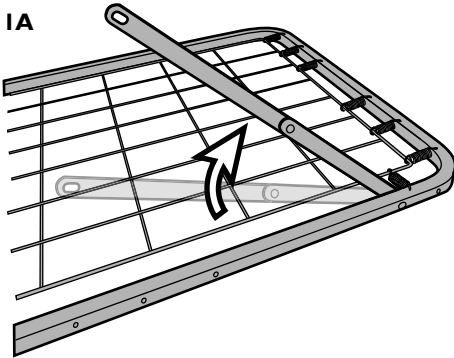

1B Swing the long arm down and find the hole corresponding to the level in which you want the mattress support to be at. Repeat Steps 1A and 1B for all 4 arms. **NOTE: It is important to lower the mattress support as you child grows.**

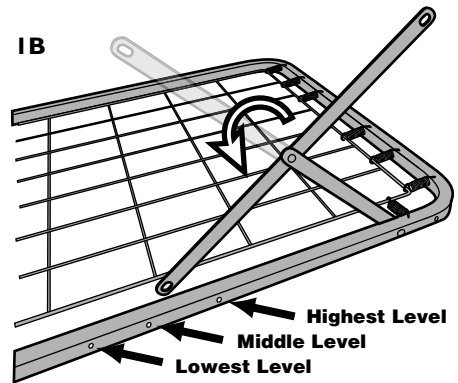

1C Attach the support bar to one end of the arm and attach the mattress support to the other end using the phillips bolt, lock washer and butterfly nut.

Make sure the other side is at the same level and do the same. The arms attach on the inside of the support bar.

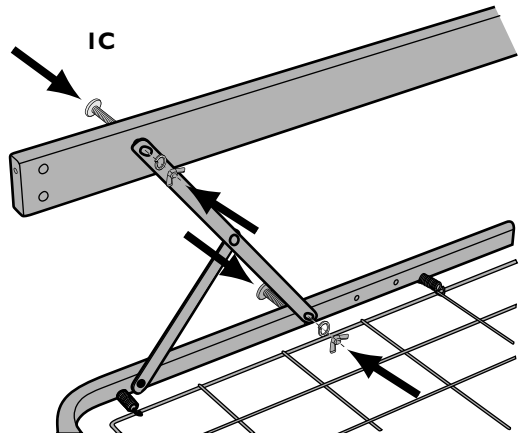

USING THE MATTRESS SUPPORT IN ANY NON-INTENDED POSITIONS MAY CAUSE SERIOUS INJURY OR HARM TO YOUR CHILD.

USE OF A POWER TOOL TO ASSEMBLE THIS CRIB MAY STRIP THE WOOD. PLEASE DO NOT USE.

2.) Attaching mattress support to left and right sides.

Hardware needed:

3-1/8" Bolts

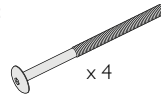

x 4



x 4

Attach each side using two 3-1/8" bolts and two barrel nuts for each side.

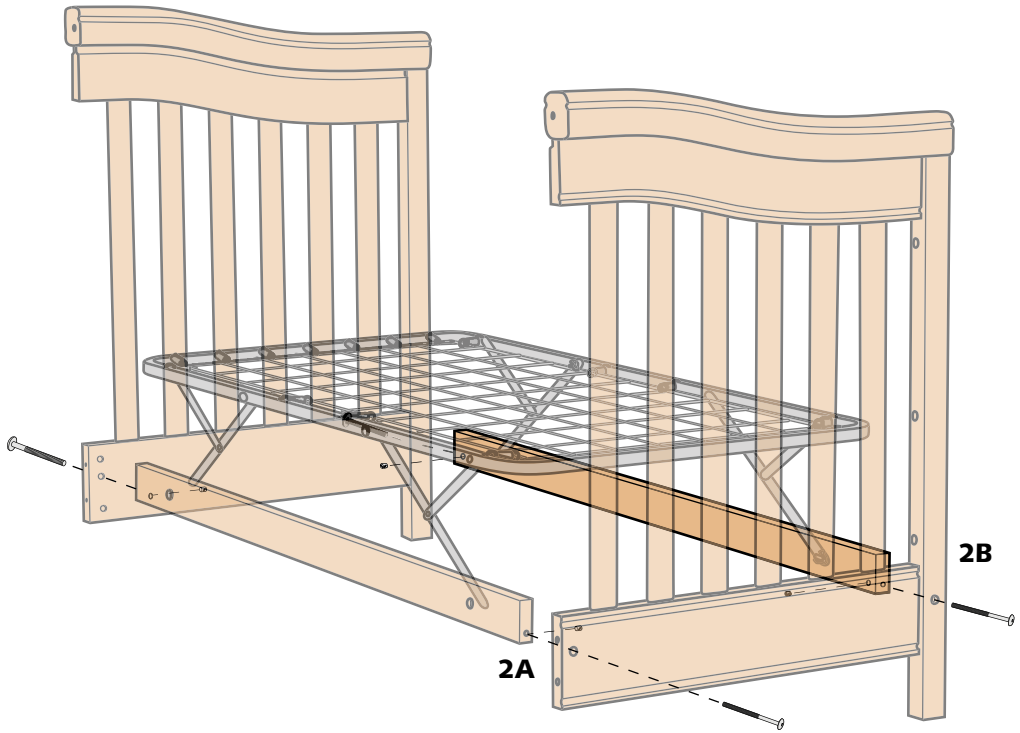

2A

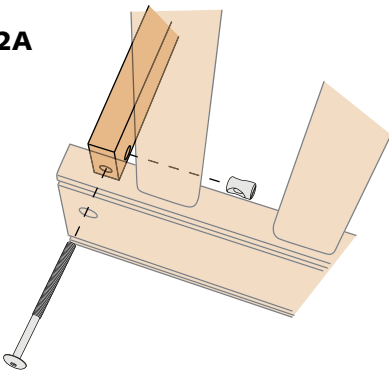

2B

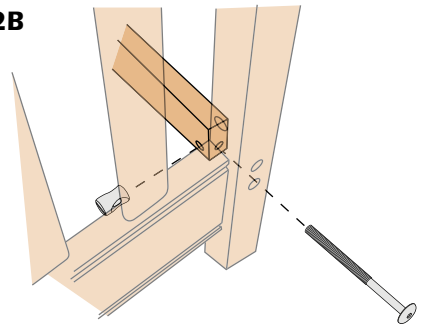

USE OF A POWER TOOL TO ASSEMBLE THIS CRIB MAY STRIP THE WOOD. PLEASE DO NOT USE.

3.) Attaching headboard.

Hardware needed:

2-3/4" Bolts

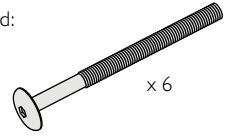

x 6

Attach headboard to mattress support/side assembly using six 2-3/4" bolts.

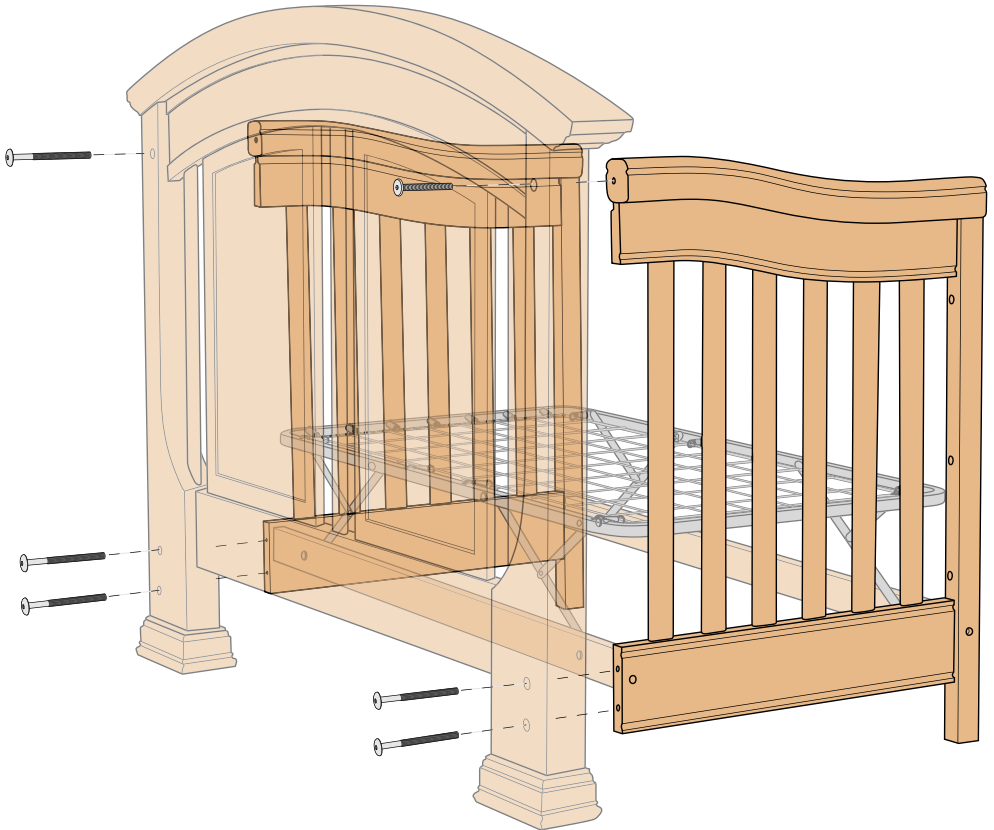

PLEASE NOTE THAT CRIB STYLE IN THE ILLUSTRATION MAY BE DIFFERENT BUT ALL HOLES AND INSERTS ARE IN THE SAME PLACE AND ASSEMBLES THE SAME.

USE OF A POWER TOOL TO ASSEMBLE THIS CRIB MAY STRIP THE WOOD. PLEASE DO NOT USE.

4.) Attaching footboard and drawer supports.

Hardware needed:

2" BOLTS

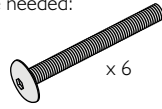

x 6



x 2

SMALL WOOD SCREWS

4A. Attach drawer supports by inserting the wooden dowels into the base of the headboard. Attach the footboard with four 2" bolts. 4B. Secure each drawer support to each headboard leg with one small wood screw.

4A

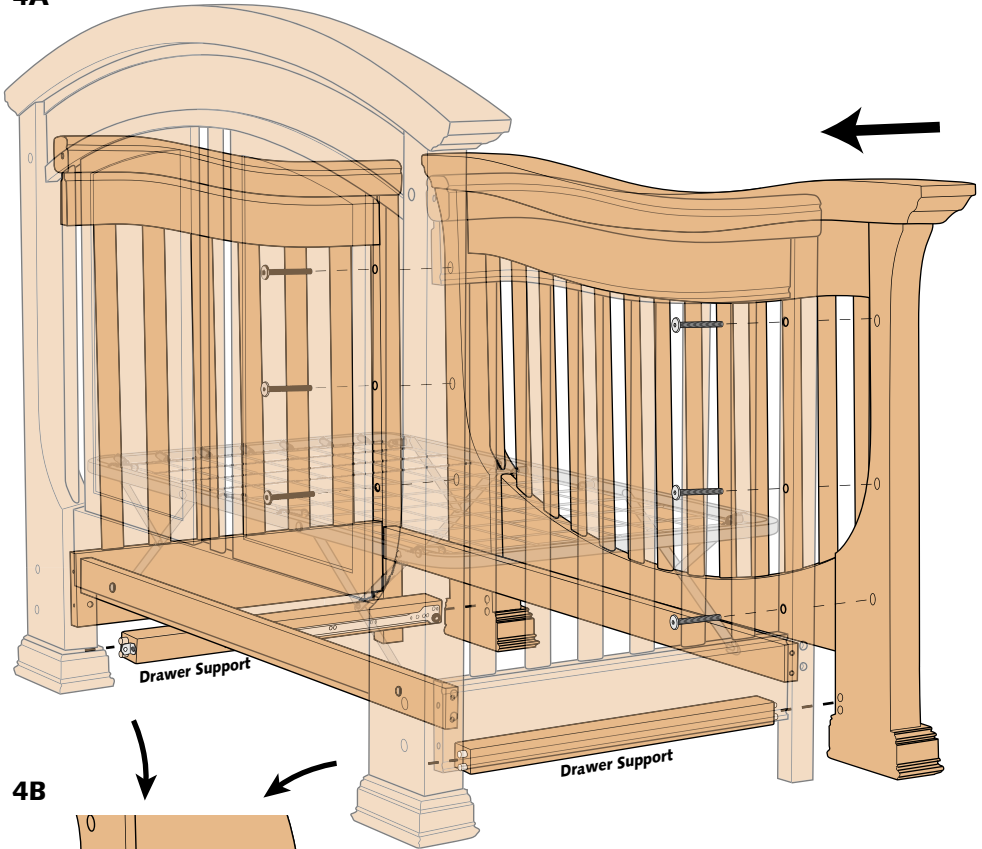

4B

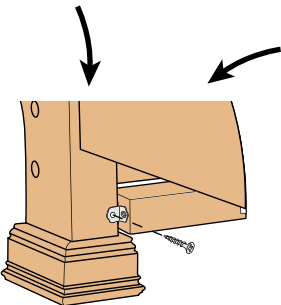

USE OF A POWER TOOL TO ASSEMBLE THIS CRIB MAY STRIP THE WOOD. PLEASE DO NOT USE.

5.) Attach drawer back to left, right and center drawer panels. Insert drawer boards.

Hardware needed:

LARGE WOOD SCREWS



5A. Attach the rear drawer panel to the drawer using 3 large wood screws. DO NOT USE POWER TOOL. DO NOT OVER-TIGHTEN. 5B. Slide drawer boards along the grooves of the panels.

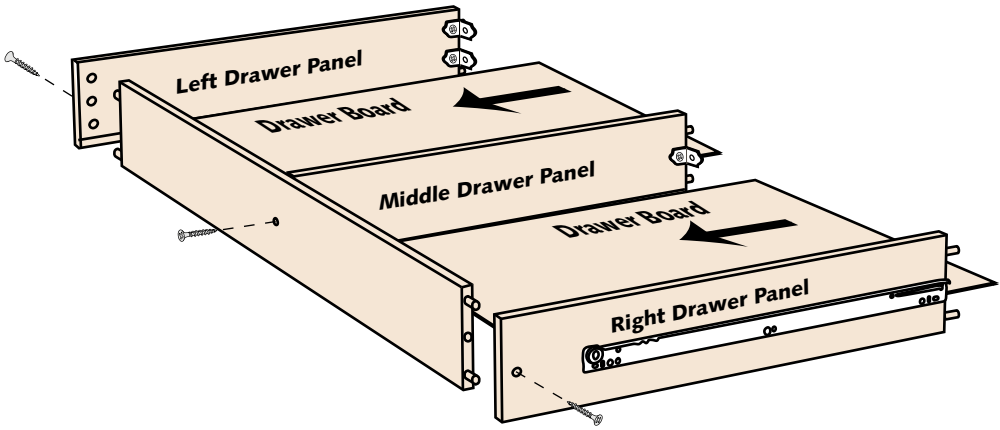

6.) Attaching front panel to drawer

Hardware needed:

SMALL WOOD SCREWS



Line up drawer face to the dowels located on the ends of the left, center and right drawer panels. Use 5 wood screws to secure the drawer face to the pre-installed angle brackets.

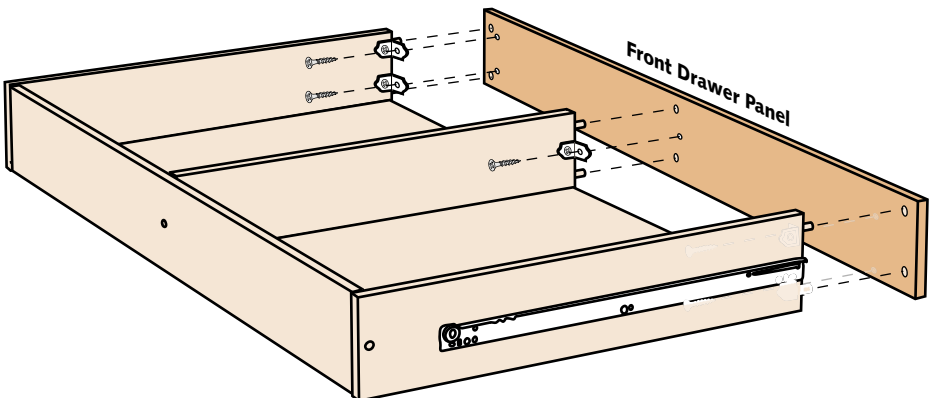

USE OF A POWER TOOL TO ASSEMBLE THIS CRIB MAY STRIP THE WOOD. PLEASE DO NOT USE.

7.) Insert drawer into crib

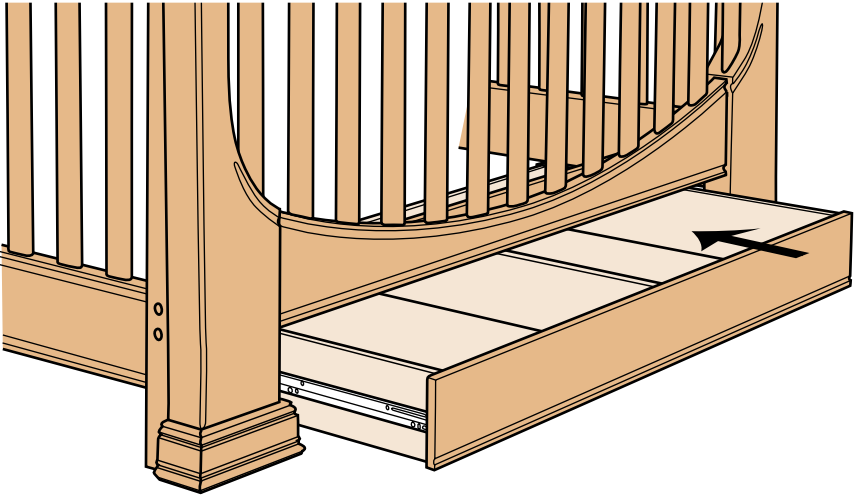

Before using the crib, please recheck all bolts and screws and make sure they are tight and secure. Be careful not to over-tighten the hardware.

READ ALL WARNINGS AND CAUTION STATEMENTS ON PAGE 10 BEFORE USING.

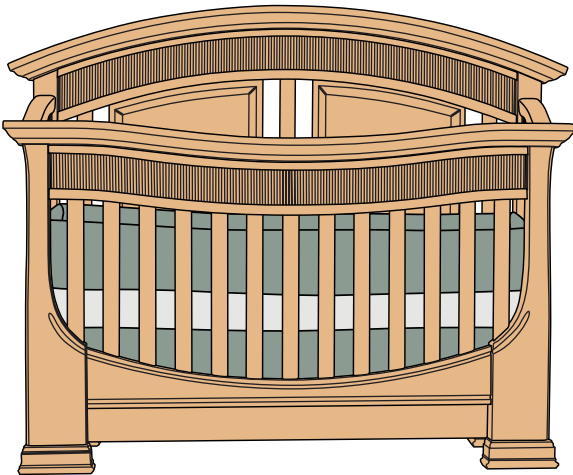

The Chelmsford converts to a toddler bed using a conversion rail that is included with the crib. Instructions to convert to a toddler bed are below.

The Chelmsford also converts to a full size bed. The full size conversion rail kit is sold separately and the instructions are included with the kit.

Converting Your Chelmsford Crib Into A Toddler Bed

The toddler bed user's minimum age must be at least 15 months old and maximum weight must not exceed 50lbs.

STEP ONE

Remove drawer from crib.

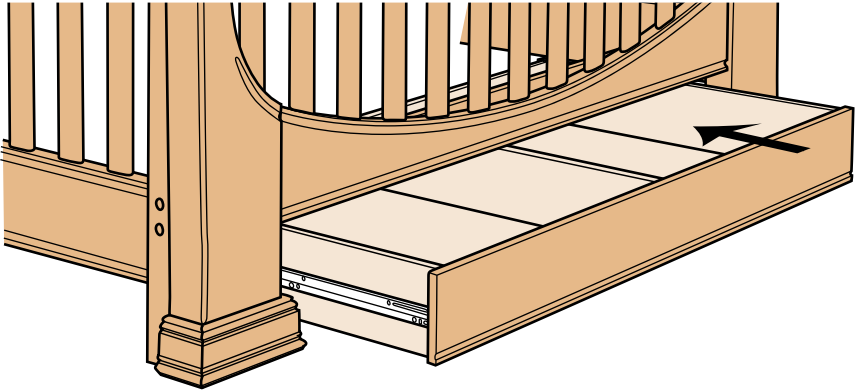

Converting Your Chelmsford Crib Into A Toddler Bed

STEP TWO

Remove the wood screws securing the drawer supports. Detach the footboard by removing six 2" inch bolts. Remove drawer supports.

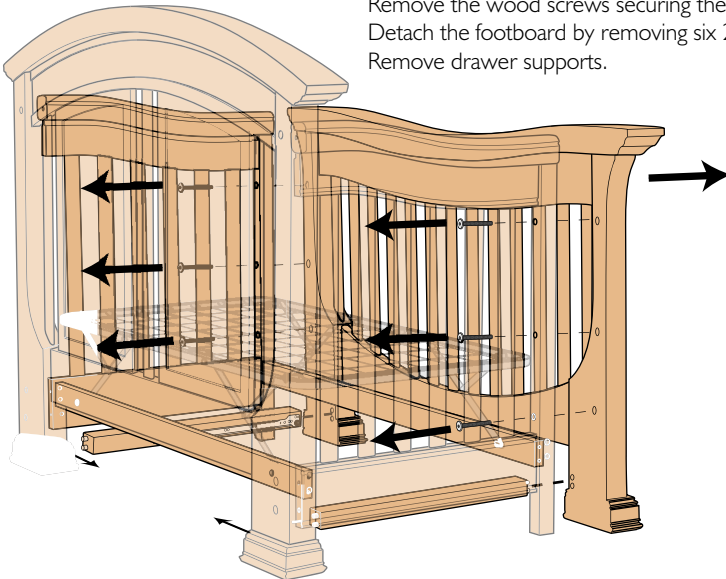

Converting Your Chelmsford Crib Into A Toddler Bed

STEP THREE

Lower the mattress support to the lowest setting. Please refer to Step #1 on how to adjust the mattress support.

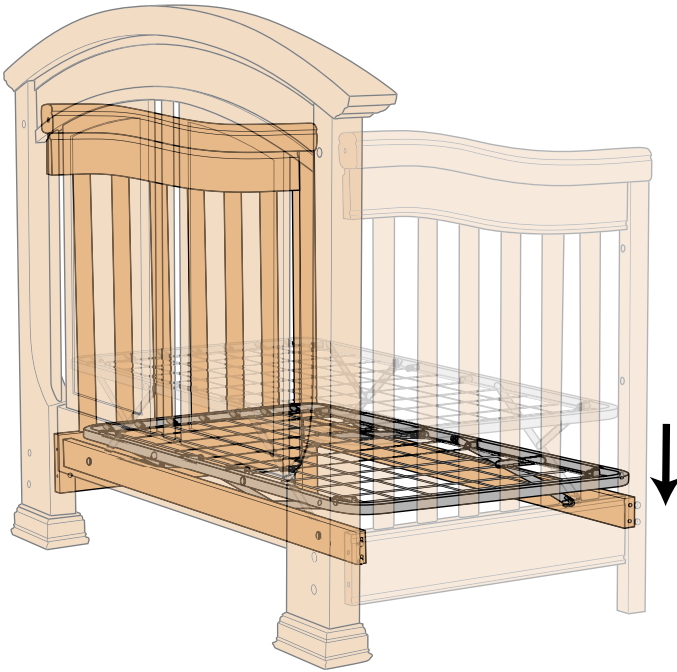

Converting Your Chelmsford Crib Into A Toddler Bed

Hardware needed:

STEP FOUR

2" Bolts

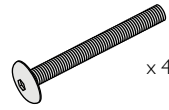

x 4

Attach the toddler rail to the left and right panels using four 2" bolts.

Recheck and make sure all bolts are securely fastened and tightened.

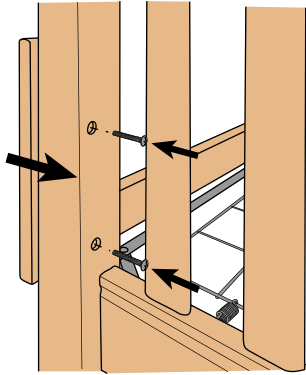

You may want to place a cloth against the side panel slats while attaching the rail to prevent scratching of the wood.

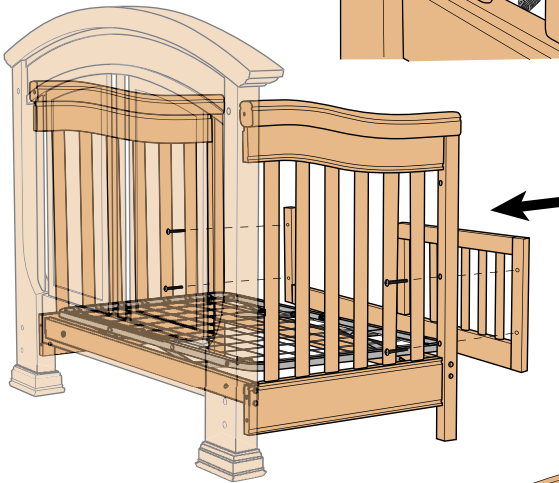
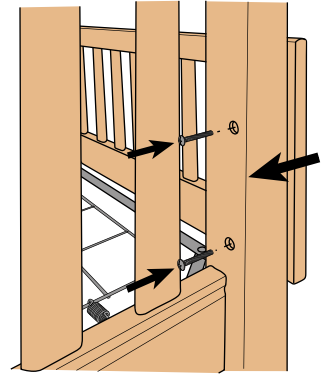

Before using the bed, please recheck all bolts and screws and make sure they are tight and secure. Be careful not to over-tighten the hardware.

!!READ ALL TODDLER BED WARNINGS AND CAUTION STATEMENTS ON PAGE 11 BEFORE USING!!

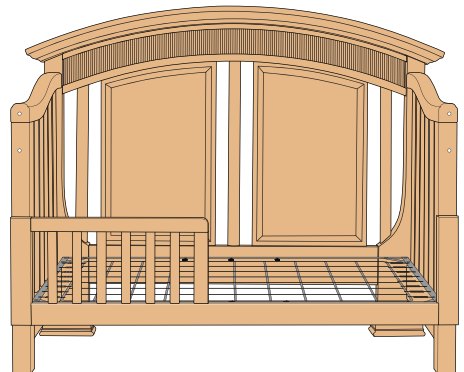

(CUT HERE TO MAIL)

GLOBAL RELEAF DONOR CARD

PLEASE PRINT CLEARLY

NAME _____

ADDRESS _____

CITY _____ STATE _____ ZIP _____

PHONE _____

EMAIL _____

CHILD'S FULL NAME _____

(As you would want it to appear on the certificate)

BIRTHDATE (MONTH/DAY) _____ SEX M F (PLEASE CIRCLE ONE)

PRODUCT PURCHASED (Check all that apply)

- Chelmsford Crib
- 4 Drawer Dresser
- 5 Drawer Dresser
- Combo Dresser
- Double Dresser
- Armoire
- Chelmsford Hutch
- Nightstand

FINISH

- Espresso
- Colonial White
- Merlot
- Heritage Cherry
- Coco

10 trees will be planted on your child's behalf to the Global Relief fund. This program involves many regions in the United States urgently needing trees.

SERIAL NO# _____
CAN BE FOUND ON A LABEL ON THE INSIDE HEADBOARD PANEL OF THE CRIB



Global ReLeaf
AMERICAN FORESTS

The Global ReLeaf program has worked with local partners to plant trees in every state in the US, and in 38 countries around the world. Millions of trees have been planted with our help in areas damaged by natural causes or human activity.

Because natural disasters like severe storms and intense wildfires can damage or destroy large numbers of trees, the program works to replant the areas that have been deforested. After Hurricane Katrina, American Forests worked with Gulf Coast communities to get new trees planted as quickly as possible. And each year, many of the projects in western forests are aimed at replanting areas that can no longer regenerate naturally because of high-intensity burns.

Restoration of any woodland will provide habitat for a wide variety of creatures, and some projects have been planted specifically to provide food and shelter for birds and animals as their habitats are destroyed or degraded by climate change, wildfire, human activity, or a number of other causes.

You will receive a certificate in the mail certifying that trees have been planted on your child's behalf and a one year subscription to American Forest's Quarterly Magazine at no charge. Please allow 8-10 weeks to process. Thank you for choosing Baby Applesed.



Baby Applesed[®]
Caring for the future

www.babyapplesed.com

in partnership with



AMERICAN FORESTS



Please mail this completed form in an envelope to:

BABY APPLESEED
15269 DON JULIAN ROAD
CITY OF INDUSTRY, CA 91745