

**Read all instructions before assembling crib. Follow all product warnings on crib. Keep the manual in the sleeve provided for future use.**



**WARNING:** Failure to follow these warnings and assembly instructions could result in serious injury or death.

**Caution:** Any mattress used in this crib must be at least 27 1/4 in by 51 5/8 in (69 cm x 131 cm) with a thickness not exceeding 6 in (15 cm).

**•This crib is to be assembled by an adult•**

- Warning: Strings can cause strangulation! Do not place items with a string around a child's neck, such as hood strings or pacifier cords. Do not suspend strings over a crib or attach strings to toys.
- DO NOT place a crib near a window where cords from blinds or drapes may strangle a child.
- Keep wall decorations, especially those with strings, completely out of a child's reach.
- Before each usage or assembly, inspect crib for damaged hardware, loose joints, missing parts or sharp edges. DO NOT use the crib if any parts are missing or broken. Ask your dealer or contact manufacturer for replacement parts and instructional literature if needed. DO NOT substitute parts.
- Check fasteners periodically for tightness. Do not overtighten. This may cause distortion or breakage.
- When a child is able to climb out, reaches the height of 35 in. (89cm) or when the height of the side rail is less than 3/4 of the child's height, the crib shall no longer be used.
- DO NOT use a water mattress with this crib. •If refinishing, use a non-toxic finish specified for children's products.
- When a child is able to pull to a standing position, set the mattress to the lowest position and remove bumper pads, large toys and other objects that could serve as steps for climbing out.
- Never use plastic shipping bags or other plastic films as mattress covers because they can cause suffocation.
- Do not tie pacifiers, necklaces, or any other items around a child's neck or on crib parts. This could cause strangulation.
- Use a crib as a crib, not as a play pen. Remember that a crib is not a substitute for a parent's supervision.
- Parents should ensure a safe environment for their child by checking the crib regularly before placing the child in the product. Please make sure that every component is properly and securely in place.
- Infants can suffocate in gaps between crib sides and a mattress too small.



**WARNING:** **Infants can suffocate on soft bedding.**  
•NEVER add a pillow, comforter or padding.  
•NEVER place additional padding under an infant.

- To help prevent strangulation, tighten all fasteners. A child can trap parts of body or clothing on loose fasteners.
- To reduce the risk of SIDS, pediatricians recommend healthy infants be placed on their back to sleep, unless otherwise advised by your physician.



## WARNING: WHEN USING AS TODDLER BED

**Failure to follow these warnings and assembly instructions could result in serious injury or death.**

---

- The intended user's minimum age must be at least 15 months old and maximum weight must not exceed 50lbs
  - DO NOT place bed near windows where cords from blinds or drapes may strangle a child
  - DO NOT place items with a string, cord, or ribbon, around a child's neck, such as a hood, strings, or pacifier cords
  - DO NOT suspend strings over a toddler bed for any reason
  - The mattress intended for this bed shall be a full-size crib mattress that must be at least 27-1/4 inches by 51-5/8 inches with a thickness not exceeding 6 inches.
- 

### CARE AND MAINTENANCE:

Periodically check your crib for any loose bolts and screws and tighten where needed. If crib is damaged, do not use - contact us for replacement parts. Clean with mild soap that is safe on wood using a soft rag. Rinse and dry thoroughly. Avoid excess moisture.

### ONE YEAR LIMITED WARRANTY:

Defective parts will be replaced within a one year period from date of original purchase. Missing parts will be replaced within 30 days from the date of original purchase. Eco-Chic Baby warrants only new units purchased in it's original packaging. The warranty does not cover used, secondhand or demos and is non-transferable.

Any damaged or defective part that result from normal wear and tear, abuse, negligence, improper use or alteration to the finish, design, and hardware of the crib, or the assembly of this product are not covered. The specific legal rights of this warranty may vary from state to state. Some states do not allow any exclusion or limitation of incidental or consequential damages. Some states do not allow limitation on how long an implied warranty lasts.

Please visit our website at **[www.ecochicbaby.com](http://www.ecochicbaby.com)**.

There you can find more product information, register for your product, contact us or request replacement parts.

Customer Service Contact:

(866) 839-6388 Toll Free

(626) 336-8861 Local

Mon-Fri 9am-5pm PST

Or you can write to us at:

Eco-Chic Baby

14001 Rosecrans Ave.

La Mirada, CA 90638

# Dorchester Classic Island

Assembly Manual

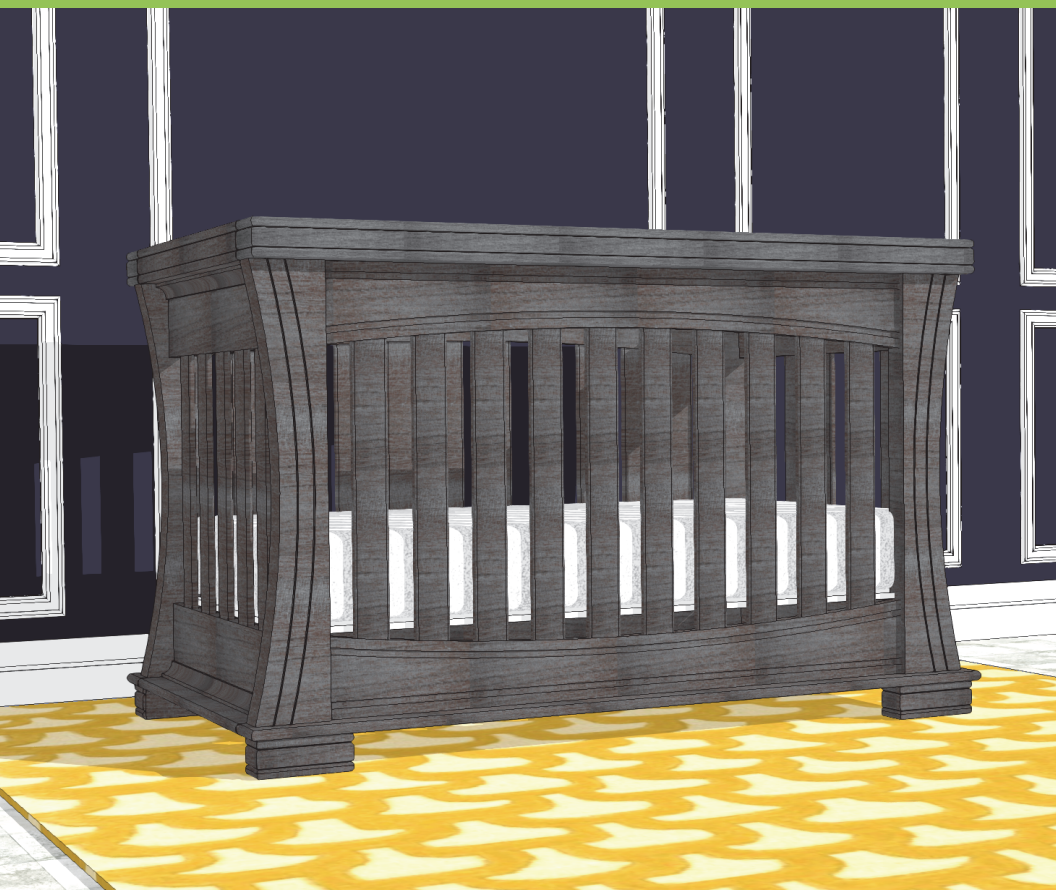

We would like to thank you for purchasing one of our cribs. Because of customers like you, we are able to make a positive impact on our environment, shaping and building a better future for all of our children.

Although caring for the environment is a priority for us at Eco-Chic Baby, you should know that our first and foremost concern is building a safe and sound product for you and your baby. Featuring solid wood construction and no moving parts, our cribs are designed to withstand the test of time; this provides for a safe and sturdy product that will grow with your baby.

Again, thank you for your support and welcome to our family.

Sincerely,  
Eco-Chic Baby

**A** Allen Head Bolt 1-3/8" ( 12 pcs )

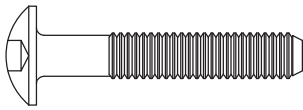

**B** Allen Head Bolt 3/4" ( 4 pcs )

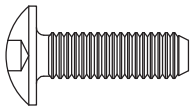

**C** Lock Washers ( 4 pcs )



**D** Hex wrench ( 1 pc )

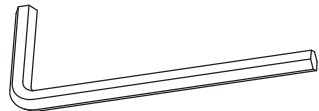

Assemble the furniture in a dirt free environment to avoid scratching or damaging the wood.

## Box Contents

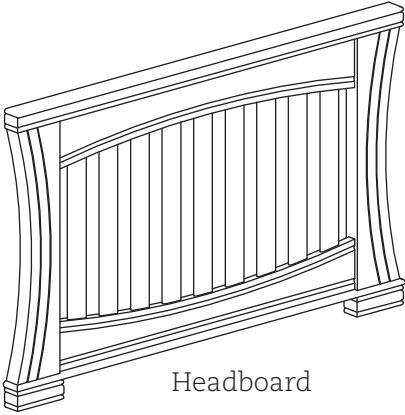

Headboard

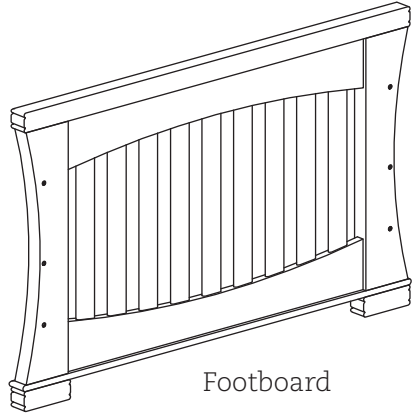

Footboard

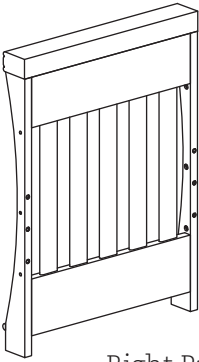

Right Panel

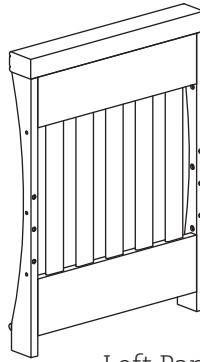

Left Panel

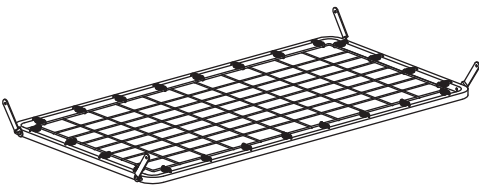

Mattress Support

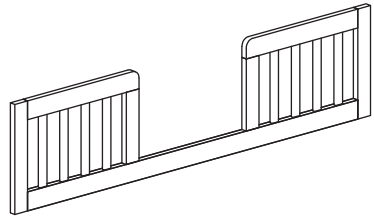

Toddler Conversion Rail  
(Sold Separately)

**HARDWARE NEEDED:**

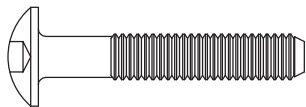

**A** Allen Head Bolt 1-3/8" (6pcs)

- 1.)** Attach each panel using three **A** 1-3/8" bolts for each side using **D** Hex wrench.

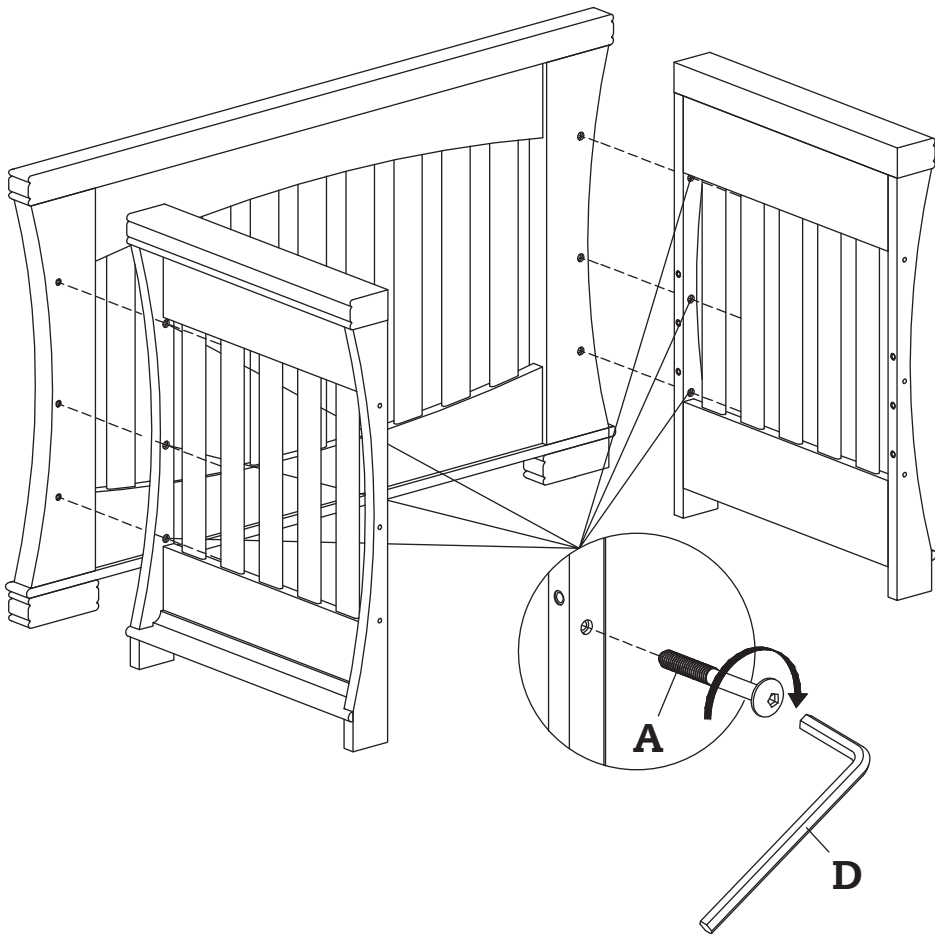

**HARDWARE NEEDED:**

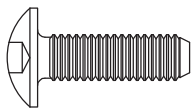

**B** Allen Head Bolt 3/4" (4pcs)



**C** Barrel Nuts (2pcs)

**2.)** Choose the level to install mattress support. Mattress is shown in its lowest position for illustration purposes only. Attach mattress support using four **B** 3/4" bolts and four **C** Locking washers using **D** Hex wrench.

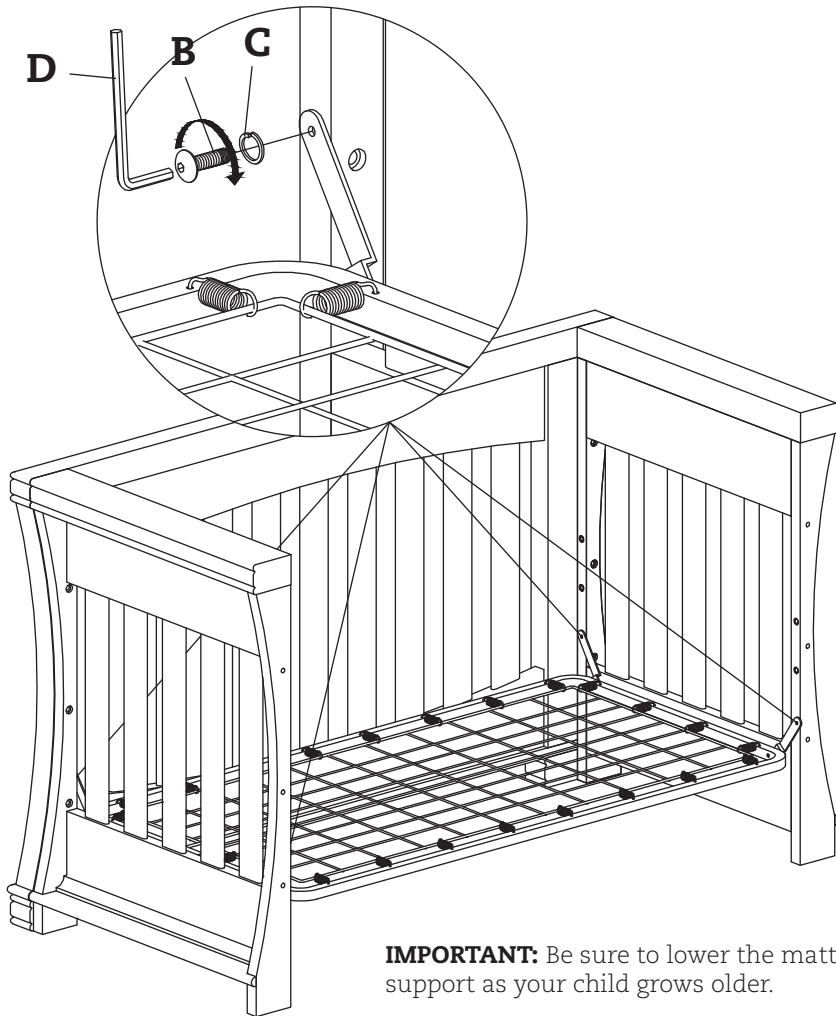

**IMPORTANT:** Be sure to lower the mattress support as your child grows older.

USE OF A POWER TOOL TO ASSEMBLE THIS CRIB MAY STRIP THE WOOD. PLEASE DO NOT USE.

**HARDWARE NEEDED:**

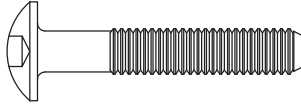

**A** Allen Head Bolt 1-3/8" (6pcs)

**3.)** Attach footboard using six **A** 1-3/8" bolts using **D** Hex wrench.

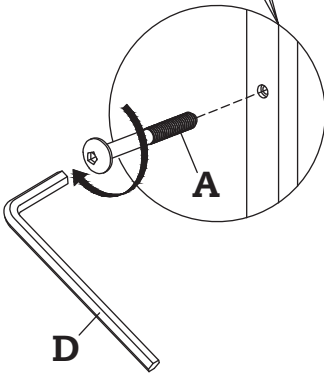
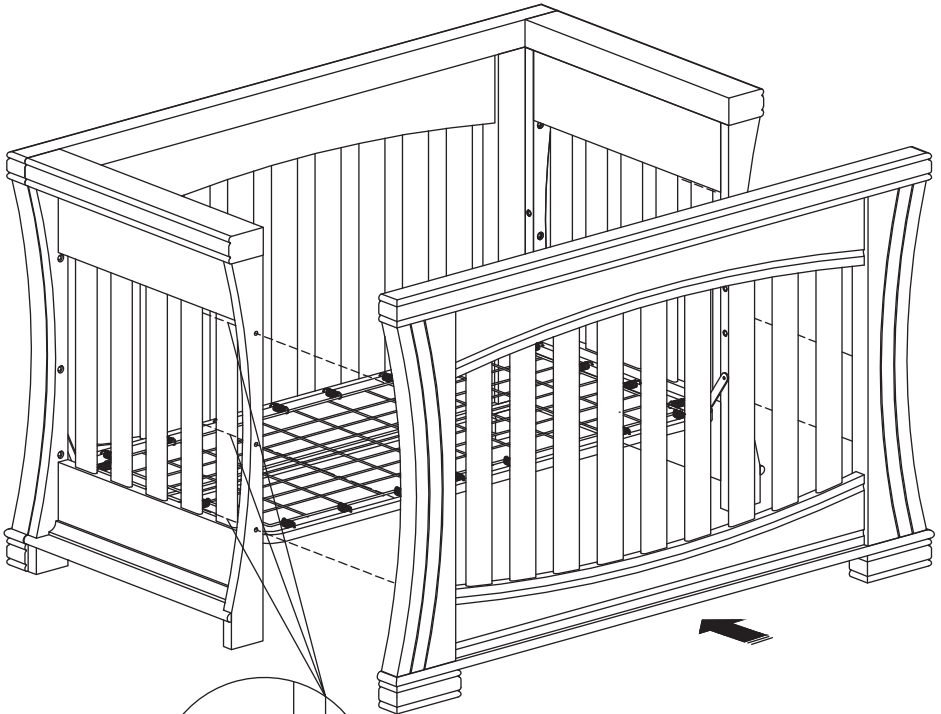



**Before using the crib, please recheck all bolts and screws and make sure they are tight and secure. Be careful not to over-tighten the hardware.**

**READ ALL WARNINGS AND CAUTION STATEMENTS ON PAGE 9 BEFORE USING.**

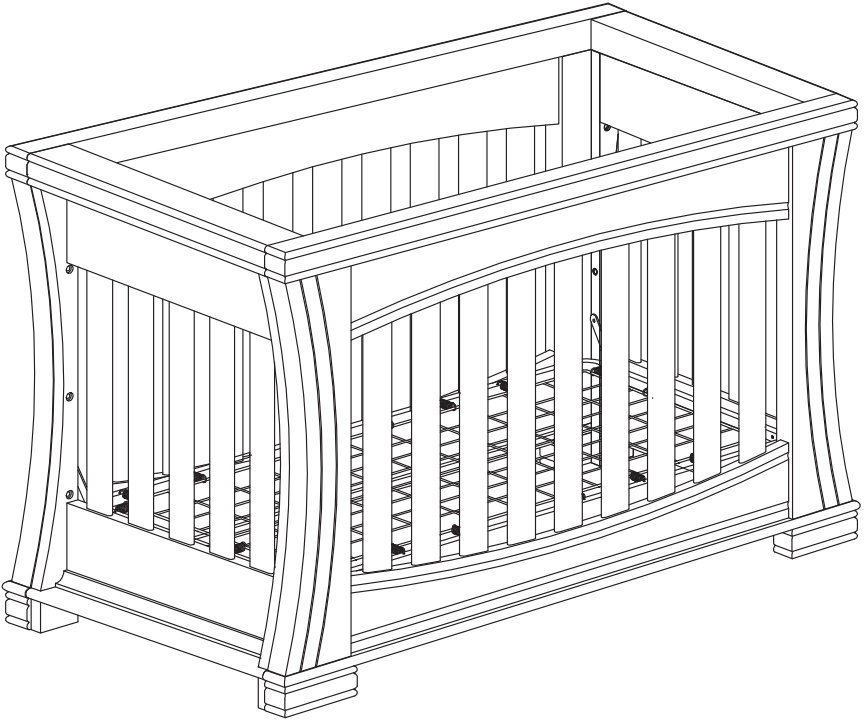

The Dorchester Classic Island crib converts to a toddler bed using a conversion rail that is sold separately. Instructions to convert to a toddler bed are on page 5.

The Dorchester Classic Island crib also converts to a full size bed. The full size conversion rail kit is sold separately and the instructions are included with the kit.

# TODDLER CONVERSION ASSEMBLY INSTRUCTIONS

## Converting Your Dorchester Classic Island Crib Into A Toddler Bed

The toddler bed user's minimum age must be at least 15 months old and maximum weight must not exceed 50lbs.

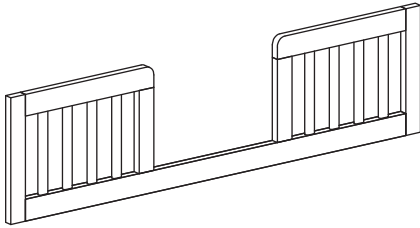

**Guard Rail  
Sold Separately**

### STEP ONE

Detach footboard from crib by removing six 1-3/8" bolts with hex wrench. The bolts will be reused for step three.



# TODDLER CONVERSION ASSEMBLY INSTRUCTIONS

## Converting Your Dorchester Classic Island Crib Into A Toddler Bed

The toddler bed user's minimum age must be at least 15 months old and maximum weight must not exceed 50lbs.

**STEP TWO** Lower mattress support to the lowest setting.

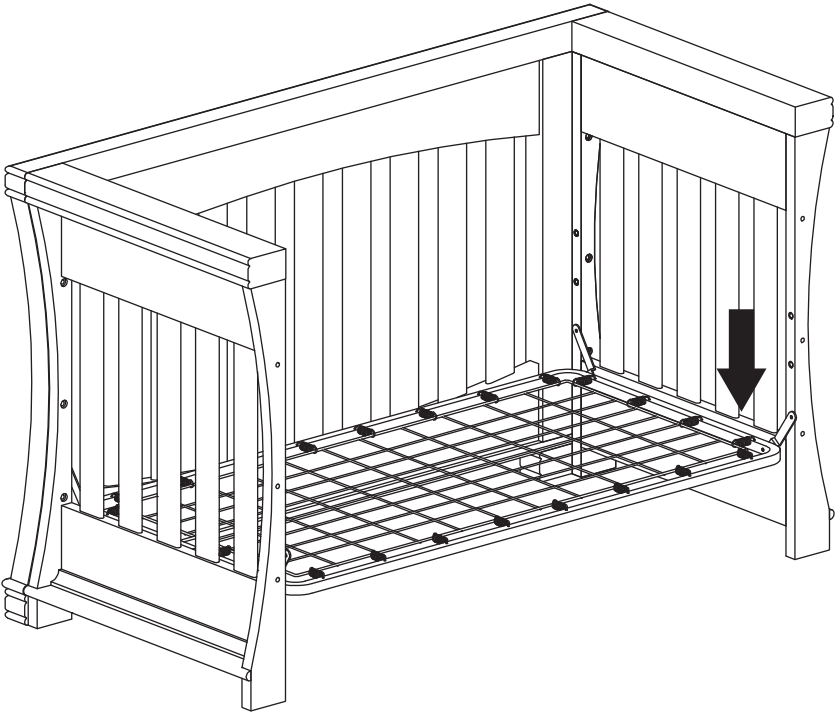

# TODDLER CONVERSION ASSEMBLY INSTRUCTIONS

## Converting Your Dorchester Classic Island Crib Into A Toddler Bed

The toddler bed user's minimum age must be at least 15 months old and maximum weight must not exceed 50lbs.

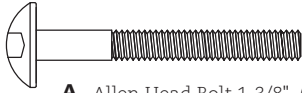

**A** Allen Head Bolt 1-3/8" (4pcs)



Allen wrench

**STEP THREE** Attach toddler rail using four 1-3/8" allen bolts using hex wrench

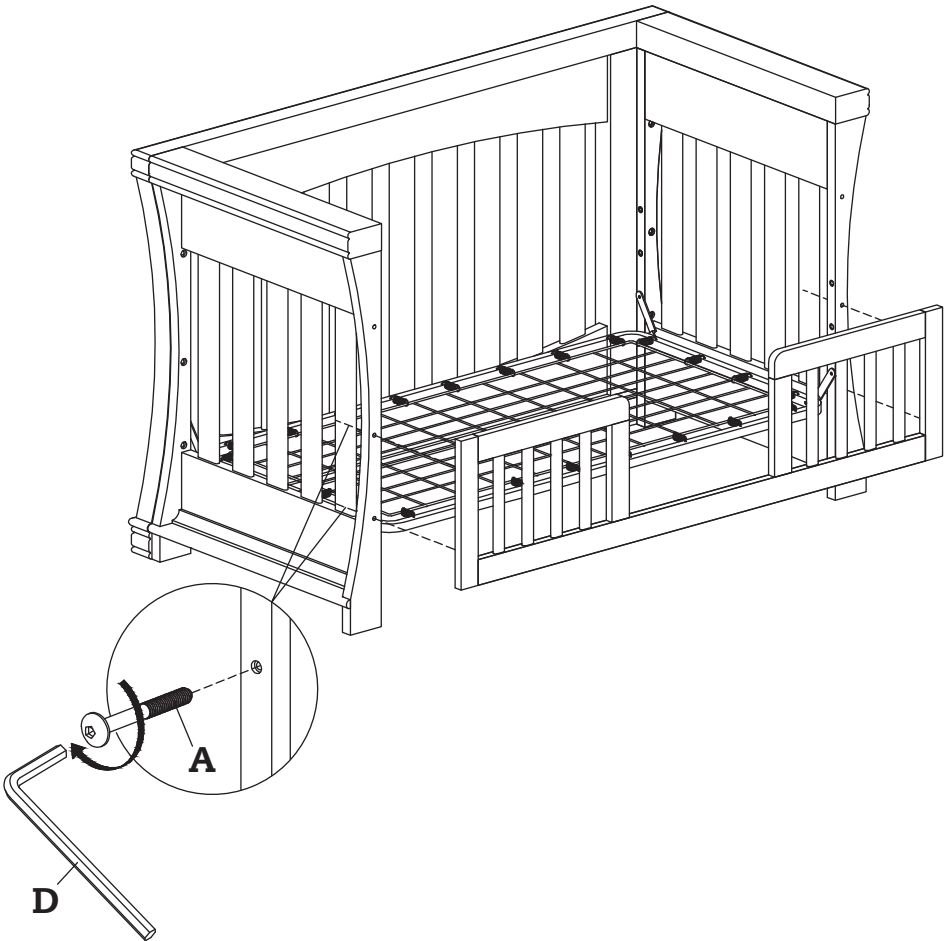

# TODDLER CONVERSION ASSEMBLY INSTRUCTIONS

## Converting Your Dorchester Classic Island Crib Into A Toddler Bed

The toddler bed user's minimum age must be at least 15 months old and maximum weight must not exceed 50lbs.

**Before using the bed, please recheck all bolts and screws and make sure they are tight and secure. Be careful not to over-tighten the hardware.**

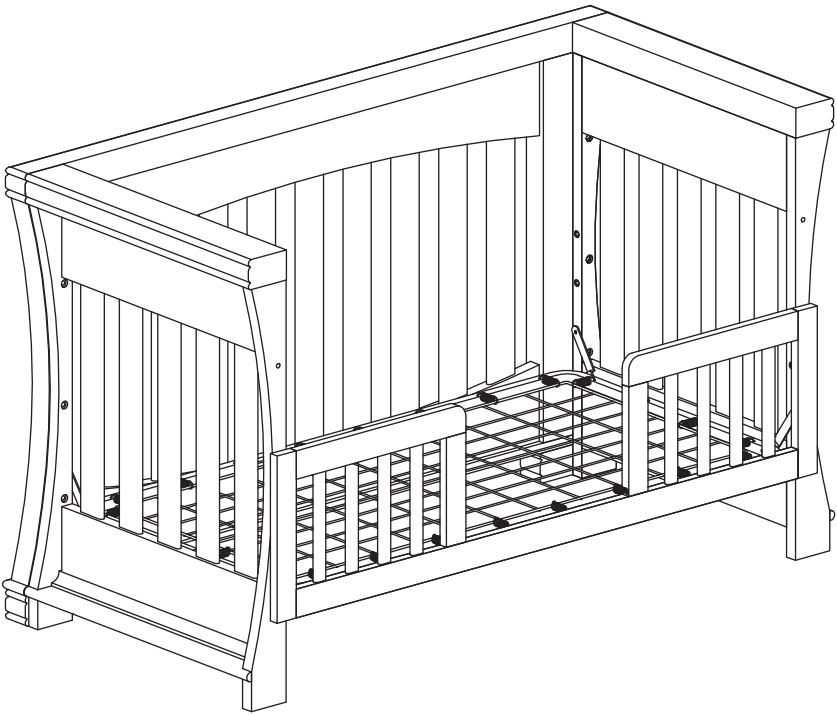

**!!READ ALL TODDLER BED WARNINGS AND CAUTION STATEMENTS ON PAGE 10 BEFORE USING!!**