

Read all instructions before assembling crib. Follow all product warnings on crib.
Keep the manual in the sleeve provided for future use..



WARNING: Failure to follow these warnings and assembly instructions could result in serious injury or death.

Caution: Any mattress used in this crib must be at least 27 1/4 in by 51 5/8 in (69 cm x 131 cm) with a thickness not exceeding 6 in (15 cm).

•This crib is to be assembled by an adult•

- Warning: Strings can cause strangulation! Do not place items with a string around a child's neck, such as hood strings or pacifier cords. Do not suspend strings over a crib or attach strings to toys.
- DO NOT place a crib near a window where cords from blinds or drapes may strangle a child.
- Keep wall decorations, especially those with strings, completely out of a child's reach.
- Before each usage or assembly, inspect crib for damaged hardware, loose joints, missing parts or sharp edges. DO NOT use the crib if any parts are missing or broken. Ask your dealer or contact manufacturer for replacement parts and instructional literature if needed. DO NOT substitute parts.
- Check fasteners periodically for tightness. Do not overtighten. This may cause distortion or breakage.
- When a child is able to climb out, reaches the height of 35 in. (89cm) or when the height of the side rail is less than 3/4 of the child's height, the crib shall no longer be used.
- DO NOT use a water mattress with this crib. •If refinishing, use a non-toxic finish specified for children's products.
- When a child is able to pull to a standing position, set the mattress to the lowest position and remove bumper pads, large toys and other objects that could serve as steps for climbing out.
- Never use plastic shipping bags or other plastic films as mattress covers because they can cause suffocation.
- Do not tie pacifiers, necklaces, or any other items around a child's neck or on crib parts. This could cause strangulation.
- Use a crib as a crib, not as a play pen. Remember that a crib is not a substitute for a parent's supervision.
- Parents should ensure a safe environment for their child by checking the crib regularly before placing the child in the product. Please make sure that every component is properly and securely in place.
- Infants can suffocate in gaps between crib sides and a mattress too small.



WARNING: Infants can suffocate on soft bedding.
•NEVER add a pillow, comforter or padding.
•NEVER place additional padding under an infant.

- To help prevent strangulation, tighten all fasteners. A child can trap parts of body or clothing on loose fasteners.
- To reduce the risk of SIDS, pediatricians recommend healthy infants be placed on their back to sleep, unless otherwise advised by your physician.



WARNING: WHEN USING AS TODDLER BED

Failure to follow these warnings and assembly instructions could result in serious injury or death.

•The intended user's minimum age must be at least 15 months old and maximum weight must not exceed 50lbs •DO NOT place bed near windows where cords from blinds or drapes may strangle a child •DO NOT place items with a string, cord, or ribbon, around a child's neck, such as a hood, strings, or pacifier cords •DO NOT suspend strings over a toddler bed for any reason •The mattress intended for this bed shall be a full-size crib mattress that must be at least 27-1/4 inches by 51-5/8 inches with a thickness not exceeding 6 inches.

CARE AND MAINTENANCE:

Periodically check your crib for any loose bolts and screws and tighten where needed. If crib is damaged, do not use - contact us for replacement parts. Clean with mild soap that is safe on wood using a soft rag. Rinse and dry thoroughly. Avoid excess moisture.

ONE YEAR LIMITED WARRANTY:

Defective parts will be replaced within a one year period from date of original purchase. Missing parts will be replaced within 30 days from the date of original purchase. Baby Appleseed warrants only new units purchased in it's original packaging. The warranty does not cover used, secondhand or demos and is non-transferable.

Any damaged or defective part that result from normal wear and tear, abuse, negligence, improper use or alteration to the finish, design, and hardware of the crib, or the assembly of this product are not covered. The specific legal rights of this warranty may vary from state to state. Some states do not allow any exclusion or limitation of incidental or consequential damages. Some states do not allow limitation on how long an implied warranty lasts.

Please visit our website at www.babyappleseed.com. There, you can find more product information register for your products, contact us or order replacement parts.

Or you can write to us at:
Baby Appleseed
14001 Rosecrans Ave
La Mirada, CA 90638

Customer Service: 562-926-9816
Hours: M-F 9AM - 5PM



PARK AVENUE

TODDLER RAIL KIT





Baby Appleseed®
Caring for the future

PARK AVENUE

TODDLER ASSEMBLY

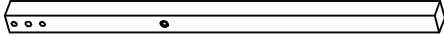
A. *Left Side Rail (1)*



B. *Right Side Rail (1)*

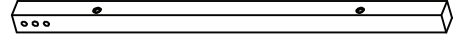

C. *Stabilizer Bar (1)*

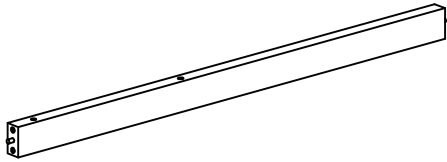

D. *Guardrail (1)*

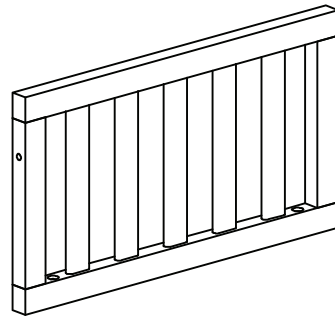

PARK AVENUE

TODDLER ASSEMBLY

1. *Allen Head Bolt 2-1/4 (4pcs)*

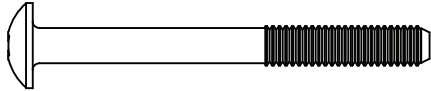

Hardware will be reused from crib when the footboard is removed.

-
2. *Allen Head Bolt 1-3/4" (11pcs)*

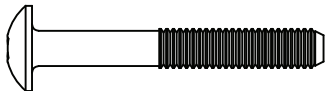

4pcs will be reused from crib when footboard legs are removed.
7pcs included with the kit.

-
3. *Allen Wrench (1pc)*

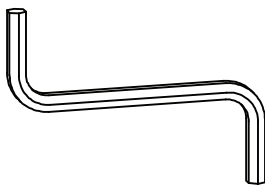

PARK AVENUE

TODDLER ASSEMBLY

Allen Wrench (1pc)

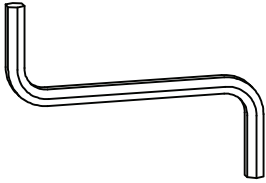

Hardware will be reused from crib when the footboard is removed for assembly on Page 6 & 7.

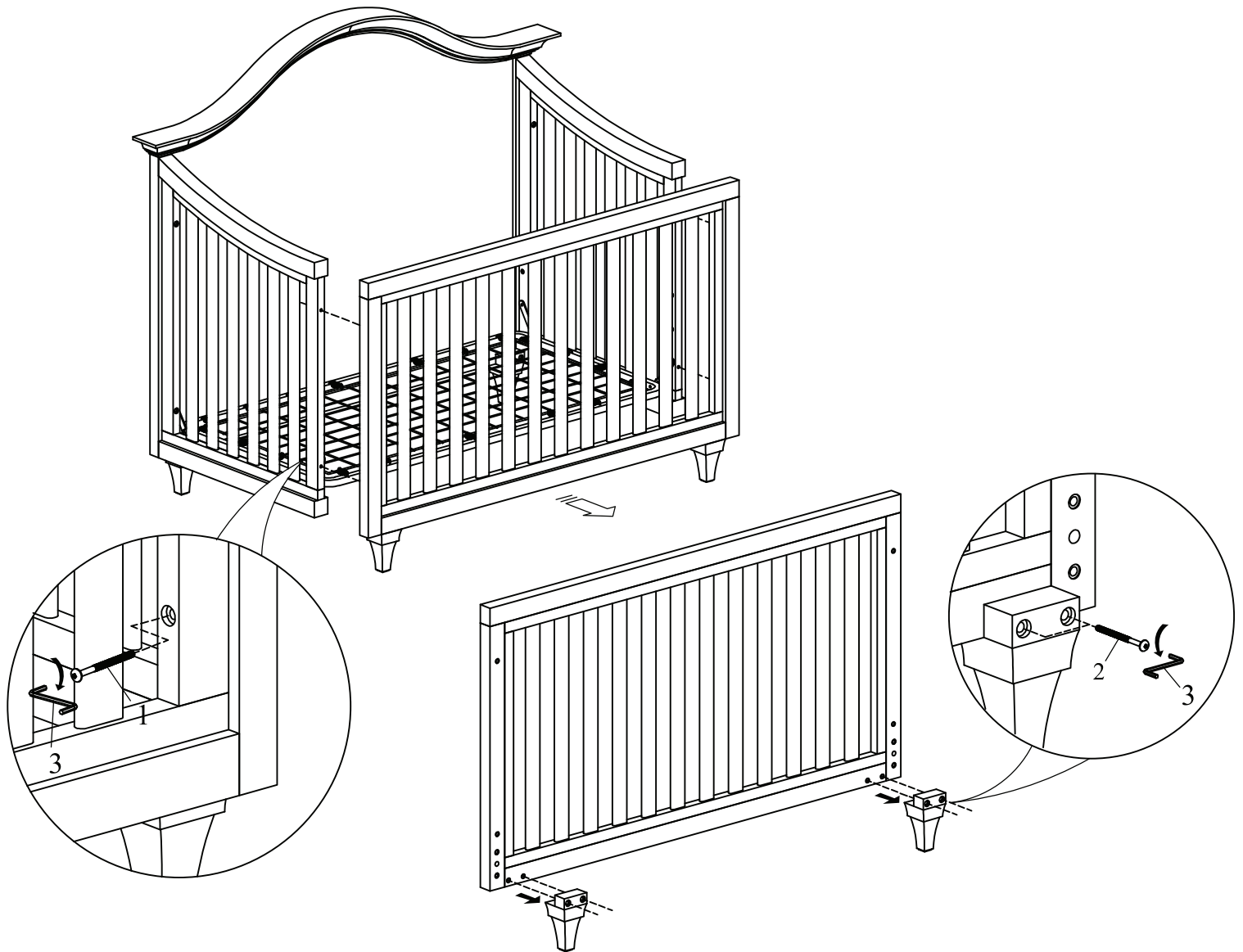

PARK AVENUE

TODDLER ASSEMBLY

Allen Head Bolt 1-3/4" (4pcs)

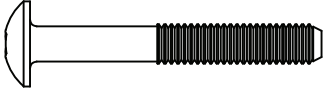

Allen Wrench (1pc)

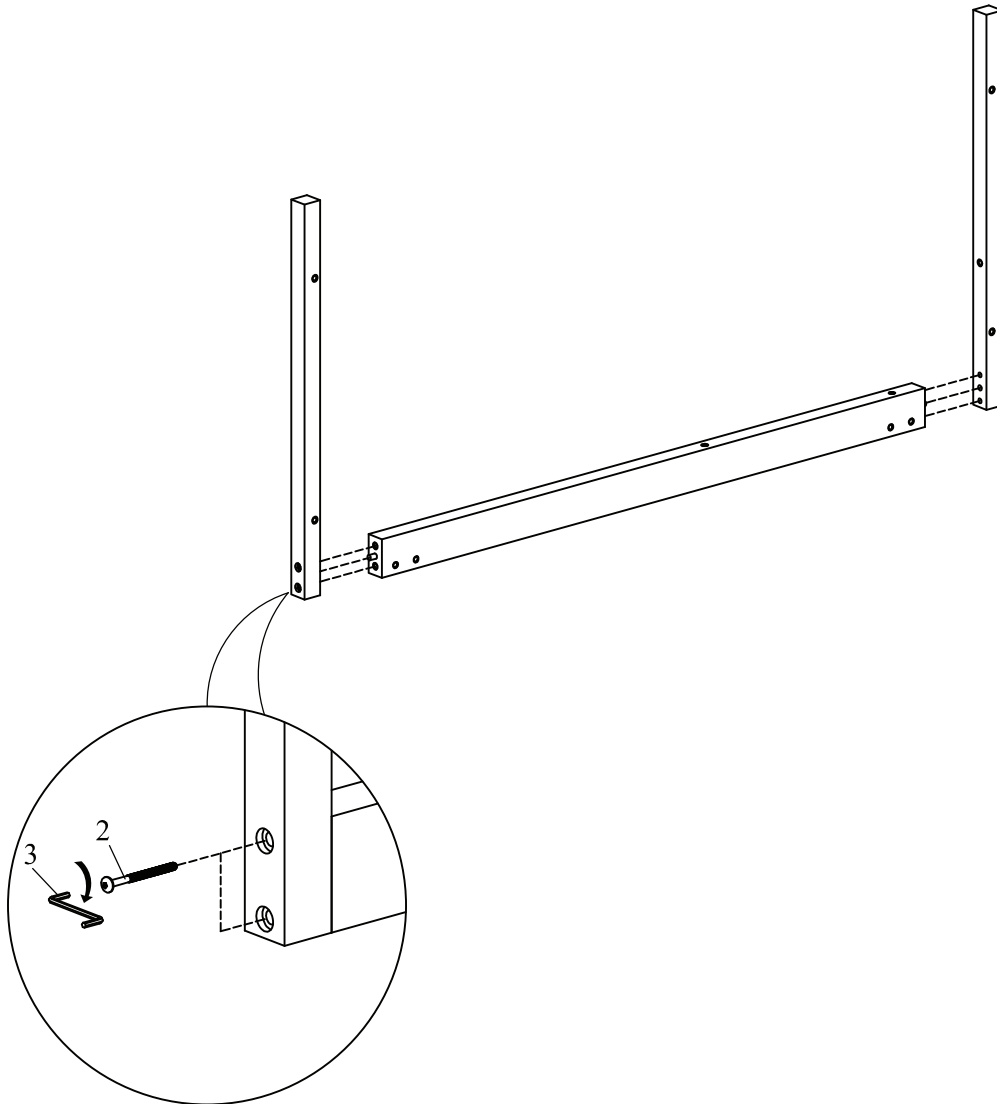
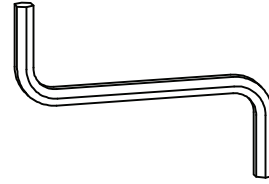

PARK AVENUE

TODDLER ASSEMBLY

Allen Head Bolt 1-3/4" (4pcs)

Allen Wrench (1pc)

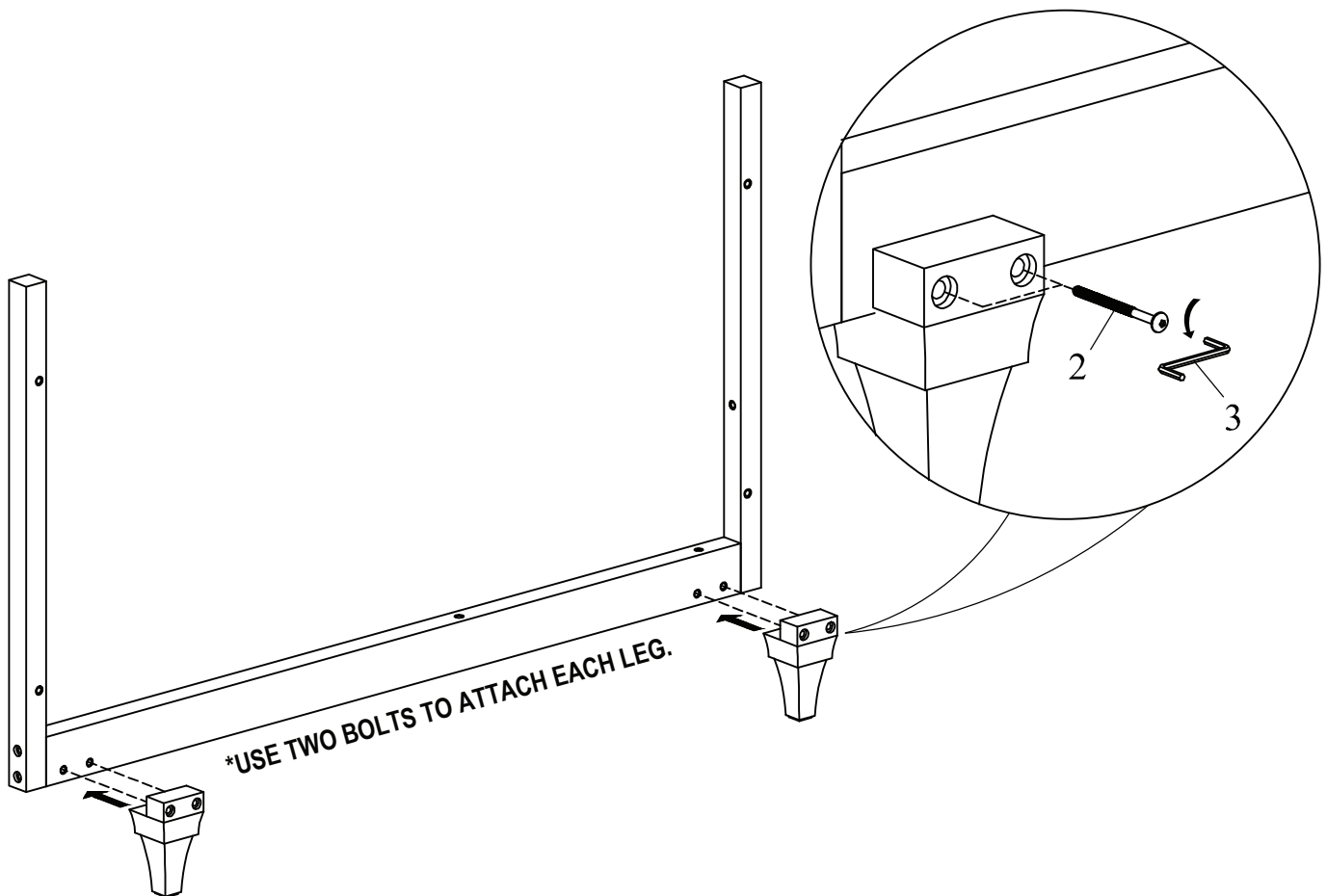
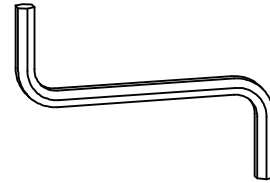
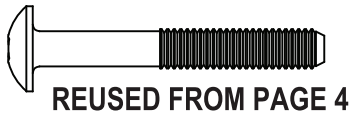

PARK AVENUE

TODDLER ASSEMBLY

Allen Head Bolt 2-1/4" (4pcs)



REUSED FROM PAGE 4

Allen Wrench (1pc)

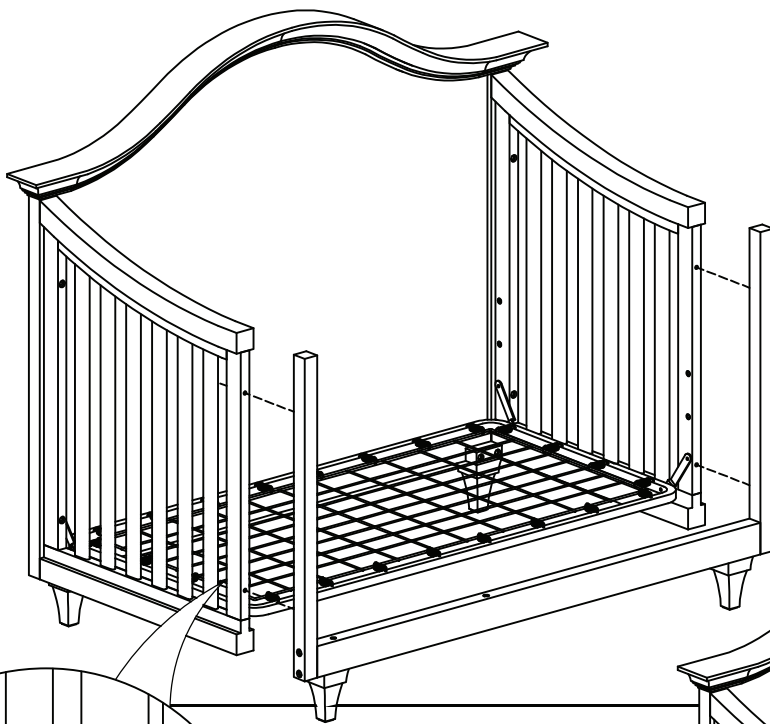
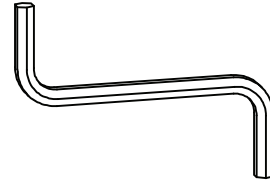

PARK AVENUE

TODDLER ASSEMBLY

Allen Head Bolt 1-3/4" (11pcs)

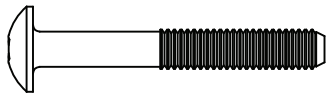

Allen Wrench (1pc)

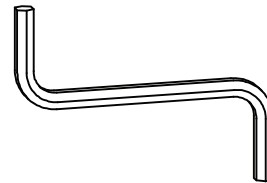

Check all screws and be sure they are fastened securely.
DO NOT OVERTIGHTEN

PARK AVENUE

DAYBED ASSEMBLY

Allen Wrench (1pc)

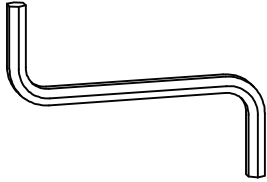

REMOVE GUARDRAIL

Please save all bolts for reconverting daybed back into toddler or crib.

